

按钮开关

Push-Button Switch

型号(TYPE): PBS-24-202

技术特性 (Specification)

- 规格 (Rating): 4A 125V AC; 2A 250V AC
- 接触电阻 (Contact R): 20mΩ max
- 绝缘电阻 (Insulation R): 500V DC 100MΩ min
- 耐电压 (Dielectric Strength): 1 Minute 1000V AC
- 电气寿命 (Electrical Life): 10,000 Cycles
- L=14.2; 11.8; 9.8

外型图 (Outline Drawing)

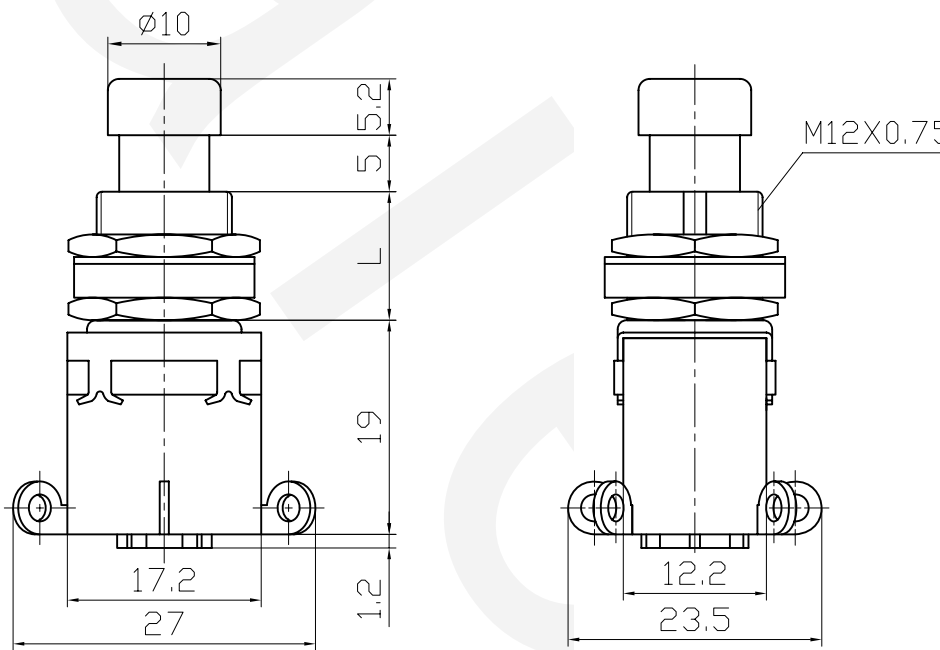

安装尺寸 (Mounting)

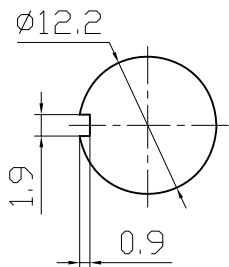

电路图 (Circuitry)

