

汽车开关 Automobile Switch

型号(TYPE): ASW-14D

技术特性 (Specification)

1. 规格 (Rating): 20A 12V DC
2. 接触电阻 (Contact R): 50mΩ max
3. 绝缘电阻 (Insulation R): 500V DC 100MΩ min
4. 耐电压 (Dielectric Strength): 1 Minute 1500V AC
5. 操作温度 (Operating Temperature): -25°C ~ +85°C
6. 电气寿命 (Electrical Life): 10, 000 Cycles

外型图 (Outline Drawing)

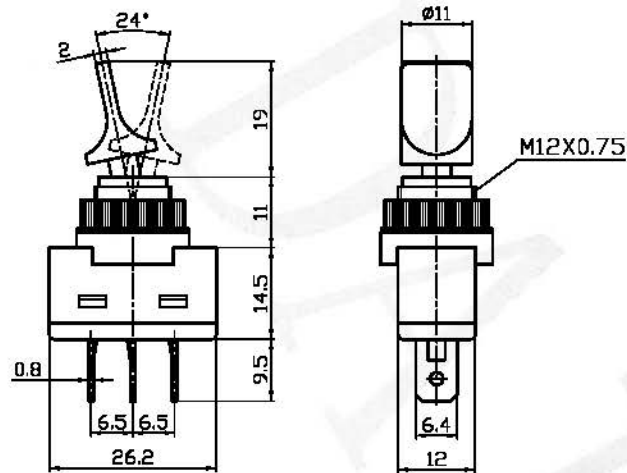

安装尺寸 (Mounting)

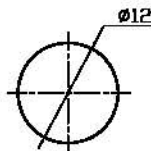

电路图 (Circuitry)

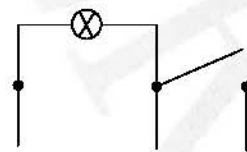

乐清戴尔电子有限公司
Yueqing Daier Electron Co., Ltd.

制图:
日期:

审核:
日期:

批准:
日期: